

Buses filetées

Pour très haute pression



HP MAX
100 bars

- Température d'utilisation : 70°C maxi
- Corps en laiton, buse en inox ou Tout en inox

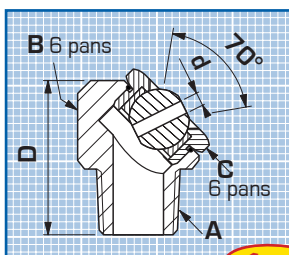

100 bars max

**Buse filetée
Type PM**

NPT - BSPT

Réf. modèle

Ø jet (mm)					Réf. modèle	
A	d	B	C	D	Laiton	inox
1/8"	3	9/16"	1/2"	20,6	PM7001	PM4039
1/8"	4	9/16"	1/2"	20,6	PM4046	PM4048
1/4"	3	5/8"	9/16"	23,8	PM7130	PM4138
1/4"	4	5/8"	9/16"	23,8	PM7140	PM4146
3/8"	4	3/4"	11/16"	28,6	PM8238	PM8239
3/8"	5,6	3/4"	11/16"	28,6	PM8248	PM8249
5/16" - 24 UNF						
5/16"	1,6	7/16"	3/8"	17,5	PM7315	PM7316
5/16"	2,2	7/16"	3/8"	17,5	PM7330	PM7332

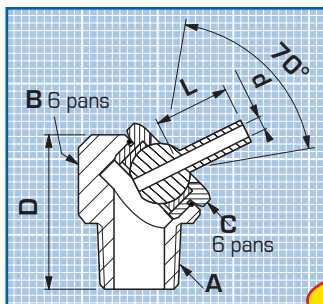

100 bars max

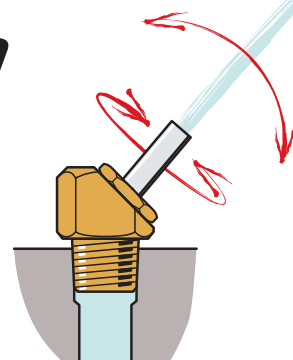

**Buse filetée
Type PM**

NPT - BSPT

Réf. modèle

Ø jet (mm)					Réf. modèle	
A	d x L	B	C	D	Laiton	inox
1/8"	1 x 6,35	9/16"	1/2"	20,6	PM4010	PM4012
1/8"	1,6 x 6,35	9/16"	1/2"	20,6	PM5010	PM4020
1/8"	1,6 x 31,7	9/16"	1/2"	20,6	PM4022	PM4024
1/8"	2,2 x 6,35	9/16"	1/2"	20,6	PM6010	PM4030
1/8"	2,2 x 31,7	9/16"	1/2"	20,6	PM4032	PM4034
1/8"	3 x 6,35	9/16"	1/2"	20,6	PM4038	PM4040
1/8"	3 x 31,7	9/16"	1/2"	20,6	PM4042	PM4044
1/4"	1 x 6,35	5/8"	9/16"	23,8	PM7100	PM4110
1/4"	1,6 x 6,35	5/8"	9/16"	23,8	PM7110	PM4120
1/4"	1,6 x 31,7	5/8"	9/16"	23,8	PM4122	PM4124
1/4"	2,2 x 6,35	5/8"	9/16"	23,8	PM7120	PM4130
1/4"	2,2 x 31,7	5/8"	9/16"	23,8	PM4132	PM4134
1/4"	3 x 6,35	5/8"	9/16"	23,8	PM4139	PM4140
1/4"	3 x 12,7	5/8"	9/16"	23,8	PM4158	PM4159
1/4"	3 x 31,7	5/8"	9/16"	23,8	PM4142	PM4144
1/4"	4 x 12,7	5/8"	9/16"	23,8	PM4148	PM4150
1/4"	4 x 31,7	5/8"	9/16"	23,8	PM4152	PM4154
3/8"	1,6 x 9,7	3/4"	11/16"	28,6	PM8210	PM8212
3/8"	1,6 x 31,7	3/4"	11/16"	28,6	PM8214	PM8216
3/8"	2,2 x 9,7	3/4"	11/16"	28,6	PM8220	PM8222
3/8"	2,2 x 31,7	3/4"	11/16"	28,6	PM8224	PM8226
3/8"	3 x 12,7	3/4"	11/16"	28,6	PM8230	PM8232
3/8"	3 x 31,7	3/4"	11/16"	28,6	PM8234	PM8236
3/8"	4 x 12,7	3/4"	11/16"	28,6	PM8240	PM8242
3/8"	4 x 31,7	3/4"	11/16"	28,6	PM8244	PM8246
3/8"	5 x 12,7	3/4"	11/16"	28,6	PM8258	PM8260
3/8"	5,6 x 12,7	3/4"	11/16"	28,6	PM8250	PM8252
3/8"	5,6 x 31,7	3/4"	11/16"	28,6	PM8254	PM8256
5/16" - 24 UNF						
5/16"	1 x 6,35	7/16"	3/8"	17,5	PM7310	PM7312
5/16"	1,6 x 6,35	7/16"	3/8"	17,5	PM7320	PM7322

● Pièces détachées :

Têtes d'arrosage (page 29)

Têtes compactes filetées

Pour très haute pression

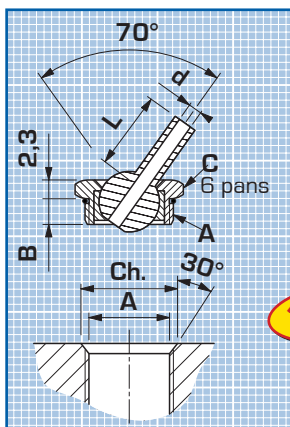

100 bars max

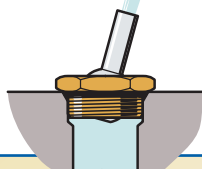

Tête filetée
Type PM

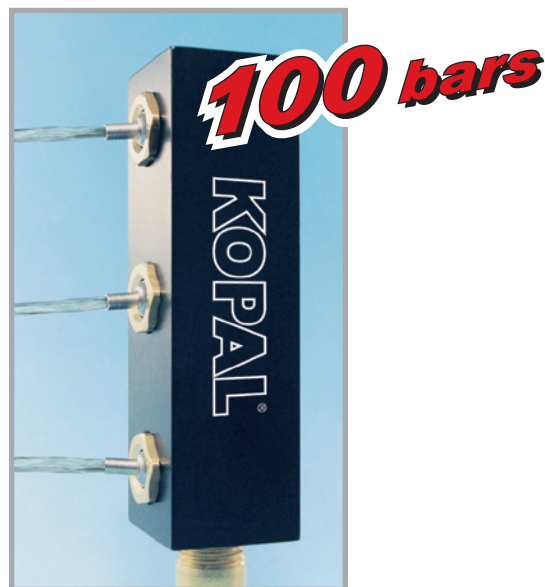

Bloc d'arrosage
(devis sur demande)

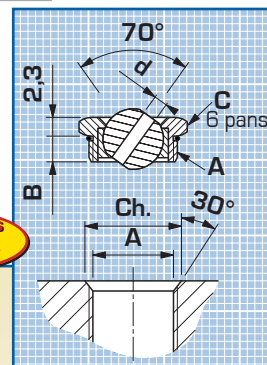

100 bars max

Tête filetée
Type PM

Ø jet (mm)		Réf. modèle				
A	d x L	B	C	Ch.Ø	Laiton	inox
5/16" - 24 UNF						
5/16"	1 x 6,35	3,5	3/8"	8,75	PM8410	PM8412
5/16"	1,6 x 6,35	3,5	3/8"	8,75	PM8420	PM8422
7/16" - 20 UNF						
7/16"	1 x 6,35	4	1/2"	11,9	PM5020	PM4505
7/16"	1,6 x 6,35	4	1/2"	11,9	PM4510	PM4512
7/16"	1,6 x 31,7	4	1/2"	11,9	PM4514	PM4516
7/16"	2,2 x 6,35	4	1/2"	11,9	PM4520	PM4522
7/16"	2,2 x 31,7	4	1/2"	11,9	PM4523	PM4524
7/16"	3 x 6,35	4	1/2"	11,9	PM4526	PM4527
7/16"	3 x 31,7	4	1/2"	11,9	PM4528	PM4529
1/2" - 20 UNF						
1/2"	1 x 6,35	4	9/16"	13,55	PM7020	PM8005
1/2"	1,6 x 6,35	4	9/16"	13,55	PM8010	PM8012
1/2"	1,6 x 31,7	4	9/16"	13,55	PM8014	PM8016
1/2"	2,2 x 6,35	4	9/16"	13,55	PM8020	PM8022
1/2"	2,2 x 31,7	4	9/16"	13,55	PM8024	PM8026
1/2"	3 x 6,35	4	9/16"	13,55	PM8029	PM8032
1/2"	3 x 12,7	4	9/16"	13,55	PM8050	PM8051
1/2"	3 x 31,7	4	9/16"	13,55	PM8034	PM8036
1/2"	4 x 12,7	4	9/16"	13,55	PM8042	PM8043
1/2"	4 x 31,7	4	9/16"	13,55	PM8044	PM8046
5/8" - 18 UNF						
5/8"	1,6 x 9,7	5,3	11/16"	16,68	PM8110	PM8112
5/8"	1,6 x 31,7	5,3	11/16"	16,68	PM8114	PM8116
5/8"	2,2 x 9,7	5,3	11/16"	16,68	PM8120	PM8122
5/8"	2,2 x 31,7	5,3	11/16"	16,68	PM8124	PM8126
5/8"	3 x 12,7	5,3	11/16"	16,68	PM8130	PM8132
5/8"	3 x 31,7	5,3	11/16"	16,68	PM8134	PM8136
5/8"	4 x 12,7	5,3	11/16"	16,68	PM8140	PM8142
5/8"	4 x 31,7	5,3	11/16"	16,68	PM8144	PM8146
5/8"	5 x 12,7	5,3	11/16"	16,68	PM8158	PM8160
5/8"	5,6 x 12,7	5,3	11/16"	16,68	PM8150	PM8152
5/8"	5,6 x 31,7	5,3	11/16"	16,68	PM8154	PM8156

Ø jet (mm)		Réf. modèle				
A	d	B	C	Ch.Ø	Laiton	inox
5/16" - 24 UNF						
5/16"	1,6	3,5	3/8"	8,75	PM8415	PM8416
5/16"	2,2	3,5	3/8"	8,75	PM8430	PM8432
7/16" - 20 UNF						
7/16"	3	4	1/2"	11,9	PM4525	PM4532
7/16"	4	4	1/2"	11,9	PM4534	PM4536
1/2" - 20 UNF						
1/2"	3	4	9/16"	13,55	PM8030	PM8028
1/2"	4	4	9/16"	13,55	PM8040	PM8041
5/8" - 18 UNF						
5/8"	4	5,3	11/16"	16,68	PM8138	PM8139
5/8"	5,6	5,3	11/16"	16,68	PM8148	PM8149

Taroud	Réf.
5/16" - 24 UNF	TA-010
7/16" - 20 UNF	TA-011
1/2" - 20 UNF	TA-012
5/8" - 18 UNF	TA-013

ARROSAGE H.P.